

# AC 5 Work

Developed by Vitra in Switzerland  
Design: Antonio Citterio



Instructions for use  
Bedienungsanleitung  
Mode d'emploi  
Manual de instrucciones  
Gebruiksaanwijzing  
Istruzioni per l'uso

**vitra.**



AC 5 Work

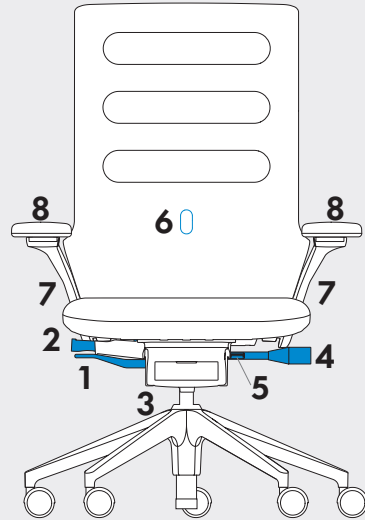

**1**

Seat height  
Sitzhöhe  
Hauteur de l'assise  
Zithoogte  
Altura del asiento  
Altezza del sedile

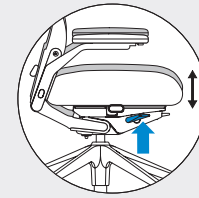

**2**

Seat depth  
Sitztiefe  
Profondeur de l'assise  
Zitdiepte  
Profundidad del asiento  
Profondità di seduta

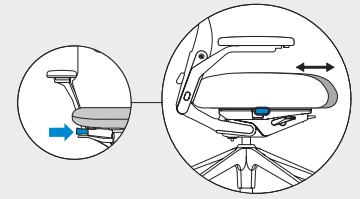

**3**

Seat tilt locking mechanism (horizontal)  
Arretierung Sitzneigung (horizontal)  
Blocage de l'inclinaison de l'assise (horizontal)  
Verstelbare zitneiging (horizontaal)  
Bloqueo de la inclinación del asiento (horizontal)  
Blocco pendenza di seduta (posizione orizzontale)

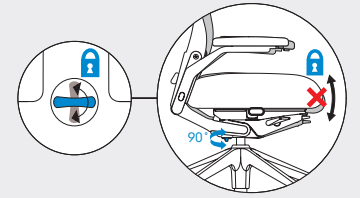

**4**

Backrest support  
Stützkraft Rückenlehne  
Résistance du dossier  
Steunkracht rugleuning  
Fuerza de apoyo del respaldo  
Intensità di sostegno dello schienale

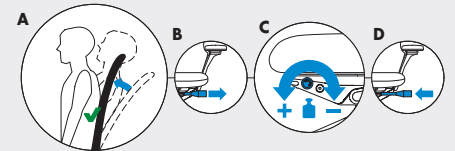

**5**

Backrest locking mechanism (upright)  
Arretierung Rückenlehne (aufrecht)  
Blocage du dossier (position droite)  
Verstelbare rugleuning (verticaal)  
Bloqueo del respaldo (recto)  
Arresto schienale (posizione eretta)

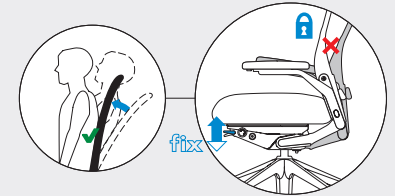

**6**

Lumbar support height (optional)  
Lumalstützenhöhe (optional)  
Hauteur du support lombaire (en option)  
Hoogte lumbale ondersteuning (optioneel)  
Altura del soporte lumbar (opcional)  
Altezza del supporto lombare (opzionale)

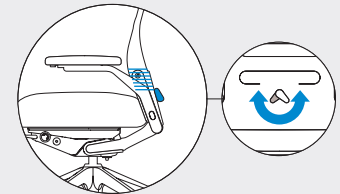

**7**

Armrest height  
Armlehnenhöhe  
Hauteur des accoudoirs  
Hoogte armleuningen  
Altura de los reposabrazos  
Altezza dei braccioli

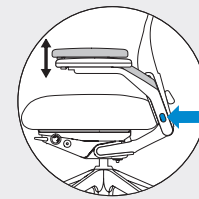

**8**

Armrest width/depth (FreeFloat)  
Armlehnenbreite/-tiefe (FreeFloat)  
Largeur/profondeur des accoudoirs (FreeFloat)  
Breedte/diepte (FreeFloat) armleuningen  
Separación, profundidad y ángulo -  
de los reposabrazos (FreeFloat)  
Larghezza/profondità dei braccioli (FreeFloat)

