

B-Line

B-Line S.r.l.
Via Galileo Galilei, 13/B
35030 - Sarameola di Rubano (PD)
ITALY

T. +39 049 8978245
F. +39 049 633499
E. info@b-line.it
W. b-line.it

BOBY

Design by Joe Colombo

DATI TECNICI / TECHNICAL DATA

- IT** Icona storica del design, il carrello contenitore si distingue per l'approccio dinamico e l'elevata versatilità. Progettato per garantire una facile componibilità verticale, permette di ottenere configurazioni diverse con capienze personalizzate. La struttura in ABS, composta da moduli con cassetti e ripiani, è montata su 5 ruote piroettanti in polipropilene e offre 4 soluzioni in termini di altezza. Parte della collezione permanente del MoMA di New York e della Triennale di Milano, Premio Smau nel 1971.
- EN** A historic designer icon, this trolley storage unit sports a dynamic approach and high degree of versatility. Designed to guarantee simple vertical modularity, it offers a wide range of different configurations to customise your storage. The ABS plastic structure, composed of drawer and shelf modules, is mounted on 5 polypropylene swivel casters and offers 4 different height solutions. Part of the permanent collection of MoMA in New York and the "Triennale" in Milan, Smau prize in 1971.
- DE** Als eines der geschichtsträchtigen Meisterwerke des Designs zeichnet sich der Rollcontainer durch seinen dynamischen Ansatz und seine beachtliche Vielseitigkeit aus. Bobby wurde geplant, um problemlos vertikale Anbaumöglichkeiten zu gewährleisten und das Fassungsvermögen in unterschiedlichen Konfigurationen individuell zu gestalten. Das Gestell aus ABS-Kunststoff bestehend aus Modulen mit Schubfächern und Böden fährt auf 5 frei drehenden Rollen und bietet 4 verschiedene Höhenausführungen. Teil der ständigen Kollektion des MoMA in New York und der Triennale in Mailand, Smau-Preis 1971.
- FR** Icône historique du design, le chariot-armoire se distingue par son approche dynamique et sa grande flexibilité. Conçu pour garantir une composition verticale simple, il permet d'obtenir différentes configurations avec des capacités personnalisées. La structure en ABS, composée de modules avec tiroirs et étagères, est montée sur 5 roulettes pivotantes en polypropylène et propose 4 solutions en termes de hauteur. Il fait partie de la collection permanente du MoMA de New York et de la Triennale de Milan, Prix Smau en 1971.
- ES** Icono histórico del diseño, este carro contenedor se caracteriza por su aspecto dinámico y la versatilidad elevada. Proyectado para garantizar una fácil componibilidad vertical, permite obtener configuraciones distintas con capacidades personalizadas. La estructura de ABS, constituida por módulos con cajones y anaqueles, se ha montado sobre 5 ruedas direccionales de polipropileno y ofrece 4 soluciones en términos de altura. Parte de la colección permanente del MoMA de Nueva York y de la Trienal de Milán, premio Smau en 1971.

BOBY — Design by Joe Colombo, 1970

H 315 — 430x420

H 525 — 430x420

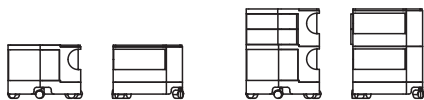

H 735 — 430x420

H 945 — 430x420

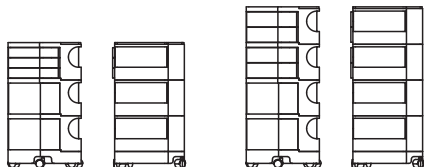

DESCRIZIONE CODICE | CODE DESCRIPTION | DESCRIPTION DU CODE | BESCHREIBUNG DES CODES | DESCRIPCIÓN DEL CÓDIGO

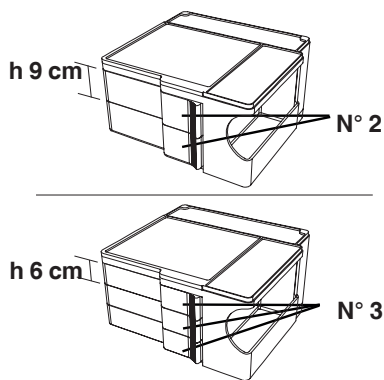

n° sezioni
 no. of sections
 Nr. Abteilungen
 n° de sections
 n. secciones

n° cassetti
 no. of drawers
 Nr. Schubkästen
 n° de tiroirs
 n. cajones

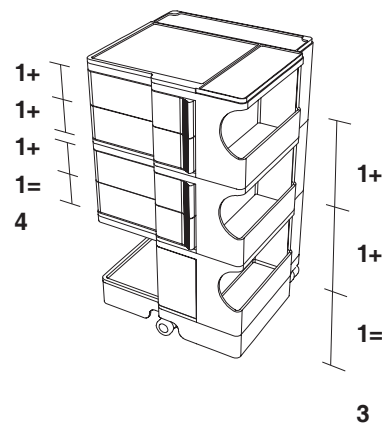

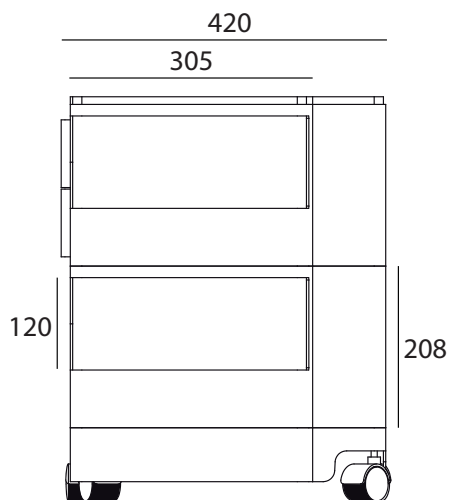
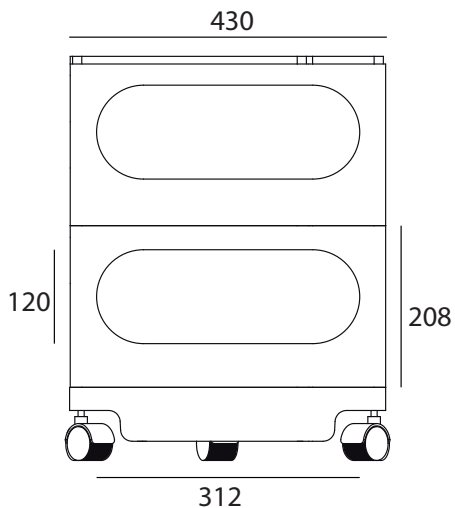
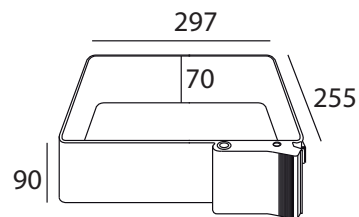
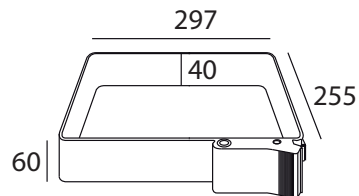
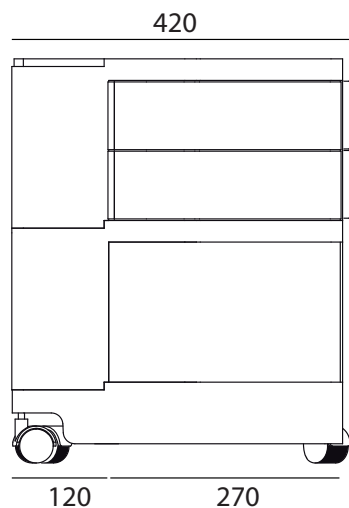
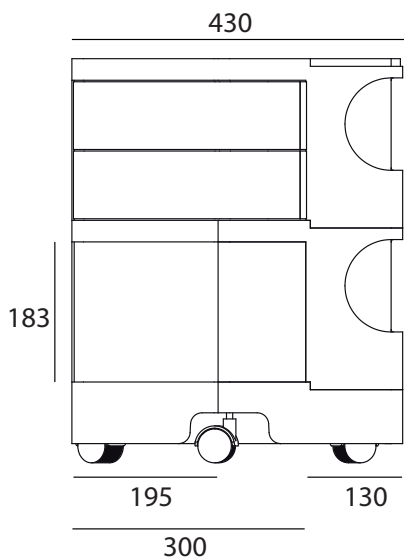
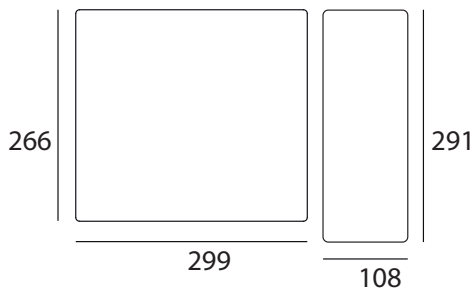
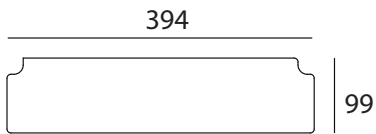
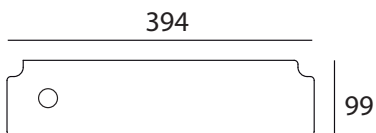
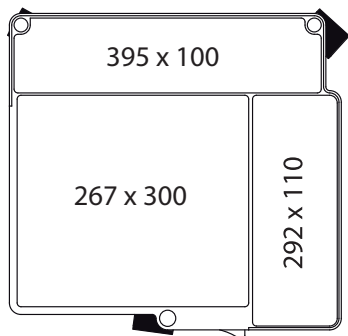

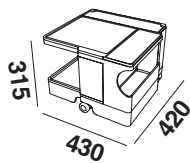

MOD. B10



tot. Kg 13

1	kg 3,80	kg 4,90	1	m³ 0,08	
Pezzi per collo Pieces per parcel Stückzahl pro Frachtstück Pièces par colis Piezas por bulto	Peso netto Net weight Nettogewicht Poids net Peso neto	Peso lordo Gross weight Bruttogewicht Poids brut Peso bruto	Numero colli Number of parcels Anzahl Frachtstücke Nombre de colis Número de bultos	Volume totale Total volume Gesamtvolumen Volume total Volumen total	Dimensioni Measures Abmessungen Dimensions Dimensiones

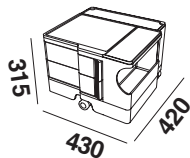

MOD. B12



tot. Kg 19

1	kg 5,40	kg 6,40	1	m³ 0,08	
Pezzi per collo Pieces per parcel Stückzahl pro Frachtstück Pièces par colis Piezas por bulto	Peso netto Net weight Nettogewicht Poids net Peso neto	Peso lordo Gross weight Bruttogewicht Poids brut Peso bruto	Numero colli Number of parcels Anzahl Frachtstücke Nombre de colis Número de bultos	Volume totale Total volume Gesamtvolumen Volume total Volumen total	Dimensioni Measures Abmessungen Dimensions Dimensiones

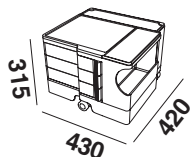

MOD. B13



tot. Kg 19

1	kg 5,50	kg 6,60	1	m³ 0,08	
Pezzi per collo Pieces per parcel Stückzahl pro Frachtstück Pièces par colis Piezas por bulto	Peso netto Net weight Nettogewicht Poids net Peso neto	Peso lordo Gross weight Bruttogewicht Poids brut Peso bruto	Numero colli Number of parcels Anzahl Frachtstücke Nombre de colis Número de bultos	Volume totale Total volume Gesamtvolumen Volume total Volumen total	Dimensioni Measures Abmessungen Dimensions Dimensiones

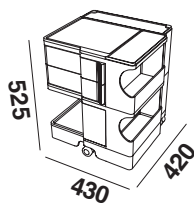

MOD. B22



tot. Kg 22

1	kg 8,10	kg 9,80	1	m³ 0,12	
Pezzi per collo Pieces per parcel Stückzahl pro Frachtstück Pièces par colis Piezas por bulto	Peso netto Net weight Nettogewicht Poids net Peso neto	Peso lordo Gross weight Bruttogewicht Poids brut Peso bruto	Numero colli Number of parcels Anzahl Frachtstücke Nombre de colis Número de bultos	Volume totale Total volume Gesamtvolumen Volume total Volumen total	Dimensioni Measures Abmessungen Dimensions Dimensiones

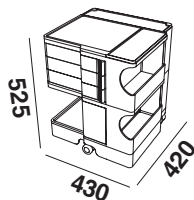

MOD. B23



tot. Kg 22

1	kg 8,25	kg 9,95	1	m³ 0,12	
Pezzi per collo Pieces per parcel Stückzahl pro Frachtstück Pièces par colis Piezas por bulto	Peso netto Net weight Nettogewicht Poids net Peso neto	Peso lordo Gross weight Bruttogewicht Poids brut Peso bruto	Numero colli Number of parcels Anzahl Frachtstücke Nombre de colis Número de bultos	Volume totale Total volume Gesamtvolumen Volume total Volumen total	Dimensioni Measures Abmessungen Dimensions Dimensiones

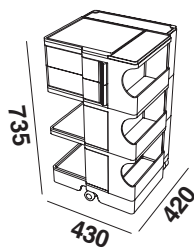

MOD. B32



tot. Kg 30

1	kg 10,45	kg 12,45	1	m³ 0,16	
Pezzi per collo Pieces per parcel Stückzahl pro Frachtstück Pièces par colis Piezas por bulto	Peso netto Net weight Nettogewicht Poids net Peso neto	Peso lordo Gross weight Bruttogewicht Poids brut Peso bruto	Numero colli Number of parcels Anzahl Frachtstücke Nombre de colis Número de bultos	Volume totale Total volume Gesamtvolumen Volume total Volumen total	Dimensioni Measures Abmessungen Dimensions Dimensiones

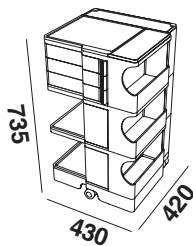

MOD. B33



tot. Kg 30

1	kg 10,85	kg 12,85	1	m ³ 0,16	
Pezzi per collo Pieces per parcel Stückzahl pro Frachtstück Pièces par colis Piezas por bulto	Peso netto Net weight Nettogewicht Poids net Peso neto	Peso lordo Gross weight Bruttogewicht Poids brut Peso bruto	Numero colli Number of parcels Anzahl Frachtstücke Nombre de colis Número de bultos	Volume totale Total volume Gesamtvolumen Volume total Volumen total	Dimensioni Measures Abmessungen Dimensions Dimensiones

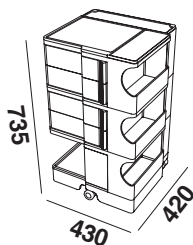

MOD. B34

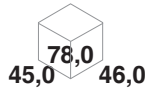

tot. Kg 31

1	kg 12,05	kg 14,05	1	m ³ 0,16	
Pezzi per collo Pieces per parcel Stückzahl pro Frachtstück Pièces par colis Piezas por bulto	Peso netto Net weight Nettogewicht Poids net Peso neto	Peso lordo Gross weight Bruttogewicht Poids brut Peso bruto	Numero colli Number of parcels Anzahl Frachtstücke Nombre de colis Número de bultos	Volume totale Total volume Gesamtvolumen Volume total Volumen total	Dimensioni Measures Abmessungen Dimensions Dimensiones

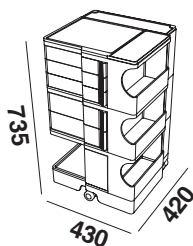

MOD. B35



tot. Kg 31

1	kg 12,45	kg 14,45	1	m ³ 0,16	
Pezzi per collo Pieces per parcel Stückzahl pro Frachtstück Pièces par colis Piezas por bulto	Peso netto Net weight Nettogewicht Poids net Peso neto	Peso lordo Gross weight Bruttogewicht Poids brut Peso bruto	Numero colli Number of parcels Anzahl Frachtstücke Nombre de colis Número de bultos	Volume totale Total volume Gesamtvolumen Volume total Volumen total	Dimensioni Measures Abmessungen Dimensions Dimensiones

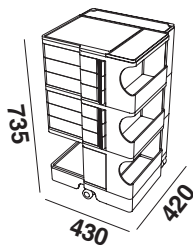

MOD. B36

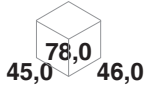

tot. Kg 31

1	kg 12,75	kg 14,75	1	m ³ 0,16	
Pezzi per collo Pieces per parcel Stückzahl pro Frachtstück Pièces par colis Piezas por bulto	Peso netto Net weight Nettogewicht Poids net Peso neto	Peso lordo Gross weight Bruttogewicht Poids brut Peso bruto	Numero colli Number of parcels Anzahl Frachtstücke Nombre de colis Número de bultos	Volume totale Total volume Gesamtvolumen Volume total Volumen total	Dimensioni Measures Abmessungen Dimensions Dimensiones

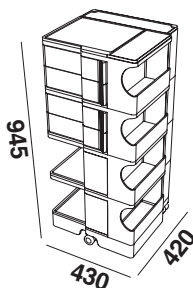

MOD. B44

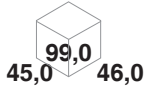

tot. Kg 39

1	kg 14,70	kg 17,00	1	m ³ 0,21	
Pezzi per collo Pieces per parcel Stückzahl pro Frachtstück Pièces par colis Piezas por bulto	Peso netto Net weight Nettogewicht Poids net Peso neto	Peso lordo Gross weight Bruttogewicht Poids brut Peso bruto	Numero colli Number of parcels Anzahl Frachtstücke Nombre de colis Número de bultos	Volume totale Total volume Gesamtvolumen Volume total Volumen total	Dimensioni Measures Abmessungen Dimensions Dimensiones

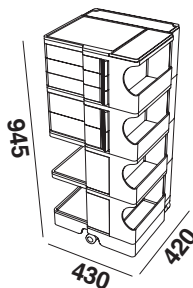

MOD. B45

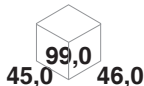

tot. Kg 39

1	kg 15,10	kg 17,40	1	m ³ 0,21	
Pezzi per collo Pieces per parcel Stückzahl pro Frachtstück Pièces par colis Piezas por bulto	Peso netto Net weight Nettogewicht Poids net Peso neto	Peso lordo Gross weight Bruttogewicht Poids brut Peso bruto	Numero colli Number of parcels Anzahl Frachtstücke Nombre de colis Número de bultos	Volume totale Total volume Gesamtvolumen Volume total Volumen total	Dimensioni Measures Abmessungen Dimensions Dimensiones

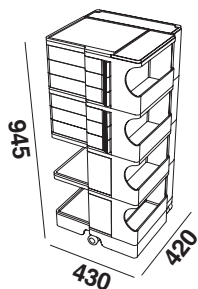

MOD. B46

 tot. Kg 39

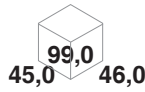
1	kg 15,40	kg 17,70	1	m ³ 0,21	
Pezzi per collo Pieces per parcel Stückzahl pro Frachtstück Pièces par colis Piezas por bulto	Peso netto Net weight Nettogewicht Poids net Peso neto	Peso lordo Gross weight Bruttogewicht Poids brut Peso bruto	Numero colli Number of parcels Anzahl Frachtstücke Nombre de colis Número de bultos	Volume totale Total volume Gesamtvolumen Volume total Volumen total	Dimensioni Measures Abmessungen Dimensions Dimensiones

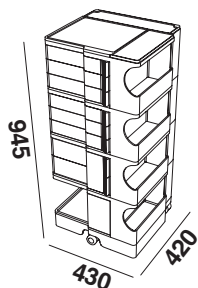

MOD. B48

 tot. Kg 40

1	kg 17,00	kg 19,30	1	m ³ 0,21	
Pezzi per collo Pieces per parcel Stückzahl pro Frachtstück Pièces par colis Piezas por bulto	Peso netto Net weight Nettogewicht Poids net Peso neto	Peso lordo Gross weight Bruttogewicht Poids brut Peso bruto	Numero colli Number of parcels Anzahl Frachtstücke Nombre de colis Número de bultos	Volume totale Total volume Gesamtvolumen Volume total Volumen total	Dimensioni Measures Abmessungen Dimensions Dimensiones

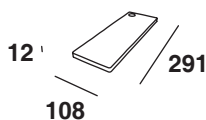
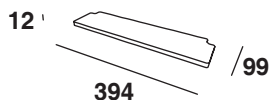

MOD. BTOP

1	kg 0,80	kg 0,97	1	m ³ 0,007	
Pezzi per collo Pieces per parcel Stückzahl pro Frachtstück Pièces par colis Piezas por bulto	Peso netto Net weight Nettogewicht Poids net Peso neto	Peso lordo Gross weight Bruttogewicht Poids brut Peso bruto	Numero colli Number of parcels Anzahl Frachtstücke Nombre de colis Número de bultos	Volume totale Total volume Gesamtvolumen Volume total Volumen total	Dimensioni Measures Abmessungen Dimensions Dimensiones

Struttura / Structure / Gestell / Structure / Estructura

Cassetti / Drawers / Schubkästen / Tiroirs / Cajones

Materiale plastico ABS, stampato ad iniezione / Injection-moulded ABS plastic material / Spritzgegossener ABS-Kunststoff / Matière plastique ABS, moulée par injection / Material plástico ABS, moldeado a inyección

Finitura / Finish / Ausführung / Finition / Acabado

 Coconut White

 Onyx Black

 Paprika

 Honey

 Cumin

 Whale

 Provenza

Tiranti, viti e perni / Tie rods, screws and pivots / Stangen, Schrauben und Stifte / Entretoises, vis et goujons / Tirantes, tornillos y pernos

Acciaio zincato / Galvanised steel / Verzinktem Stahl / Acier galvanisé / Acero galvanizado

Ruote / Casters / Rollen / Roulettes / Ruedas

Polipropilene / Polypropylene / Polypropylen / Polypropylène / Polipropileno

Piani / Tops / Tischplatten / Plateaux / Planos

Multistrato di legno / Multi-layered wood / Mehrschichtholz / Multiplis de bois / Multicapas de madera

Finitura / Finish / Ausführung / Finition / Acabado

 Rovere naturale / Natural oak / Eiche Natur / Chêne naturel / Roble natural

 Noce Canaletto / Canaletto walnut / Noyer Canaletto / Nussbaum Canaletto / Nogal Canaletto

Piani / Tops / Tischplatten / Plateaux / Planos

Sughero / Cork / Kork / Liège / Corcho

Finitura / Finish / Ausführung / Finition / Acabado

 Moka

 Naturale / Natural / Natürlicher / Naturel / Natural

Piani / Tops / Tischplatten / Plateaux / Planos

Multistrato di legno / Multi-layered wood / Mehrschichtholz / Multiplis de bois / Multicapas de madera

Finitura / Finish / Ausführung / Finition / Acabado

 Confetti
Vinile / Vinyl / Vinyl / Vinyle / Vinilo

 Volcano
Vinile / Vinyl / Vinyl / Vinyle / Vinilo